

LC-780/780HD/780LV

Passive Infrared SenSwitch



Installation Instructions

INTRODUCTION

Thank you for your purchasing IR-TEC Passive Infrared SenSwitch. It applies the advanced infrared sensing technology to provide automatic light control by detecting the human body motion. It will turn on the light instantly when motion is detected and turn off automatically after the delay time expires. SenSwitch provides not only convenience and energy saving, but also security as the unexpected, sudden light is a well know, effective means to frighten the unwanted intruder away.

INSTALLATION HINTS

- Avoid aiming the sensor head at direct or reflected sunlight which could cause permanent damage of the sensor or false operation.
- Avoid locating the SenSwitch at areas at which contain objects likely to produce a rapid temperature change such as heating vents, air conditioners dryer...etc.
- Avoid installing the SenSwitch nearby trees or at the area where public/traffic may be detected.
- Select a location where the direction of movement will be "across" the detection pattern for better sensitivity. To obtain proper detection, mounting height should be 1.8 ~ 3.0 meter on the wall or ceiling.

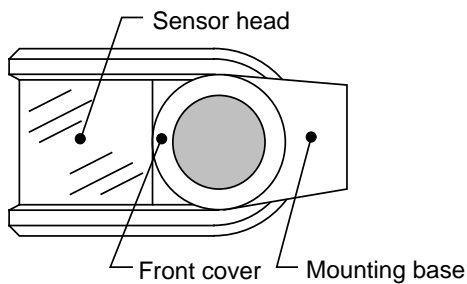

WARNING !

- Some local building codes may require installation by a qualified electrician. Consult an electrician about correct wiring.
- The main power must be switched of before installing.

INSTALLATION & WIRING

1. Remove front cover and sensor head from the mounting base by releasing two fixing screws..
2. Apply the mounting guide sticker at the selected position for drilling mounting holes. Insert dowels and mount the base with mounting screws.
3. Lead the wires from power source and light through passage hole on rubber gasket beneath the base. Connect wires to correct terminals according to following instruction for different operation mode.

LC-780/780HD

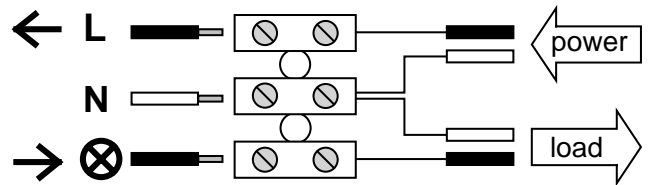

← L : Live wire from power source

N : Neutral wire

→ ⊗ : Live wire to load (light)

A. Automatic control

The following wiring enables SenSwitch to control the light automatically by detecting the motion.

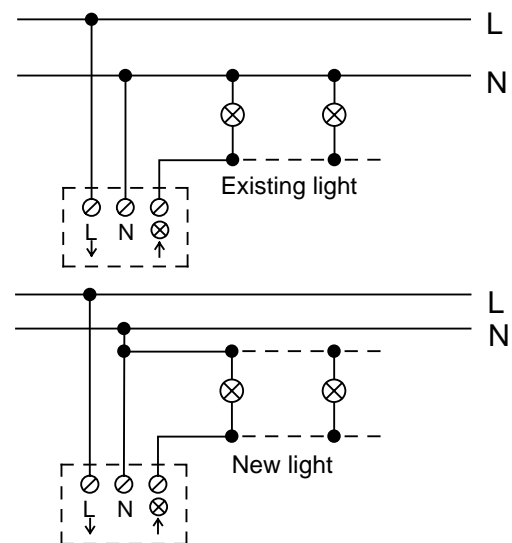

B. Automatic with manual override

The following wiring enables SenSwitch to control the light automatically while the manual switch is off. The light will remain constantly on if manual switch is on, regardless of any motion or light level.

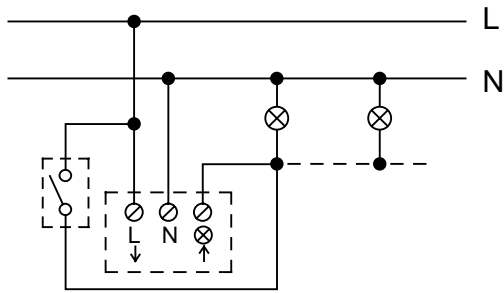

WARNING ! It is vitally important to connect the "live" and "neutral" wires of AC mains correctly. Wrong connection could cause malfunction or permanent damage to the unit.

LC-780LV Wiring Diagram

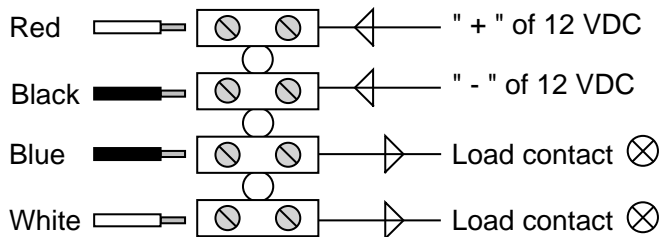

Note: The load contacts of LC-780LV is voltage free.

TEST & ADJUSTMENTS

Note: Before testing, ensure the LUX is set at right end (⊕) and the TIME is set at left end (←).

1. Aim sensor head at desired detection area. Apply the mains power and wait about 30 seconds for sensor to warm up. Light will be on during warm up period and off once warm up finished.
2. Walk across within the detection area at normal speed, light should be switched on when sensor detects the motion. Stop and wait for light off, repeat same process until the whole coverage is identified and satisfied.
3. After walk test completed, adjust the LUX and TIME trimmers as desired.

A. Range Adjustment

Maximum range can be obtained when the sensor head is set horizontal. The range can be reduced by tilting sensor head downward. The detection zones can also be masked by applying the provided masking label on the lens segments. Firstly, refer to the detection pattern diagram and locate the respective segments should be masked. Cut the masking label and stick on the segments. Range adjustment can eliminate the detections that cause unwanted light switching.

B. TIME Adjustment

TIME trimmer controls light-off delay time after the last motion is detected. Turn the trimmer clockwise to increase the delay time.

C. LUX Adjustment

LUX trimmer controls the SenSwitch operation by sensing the ambient light level. After testing completed, adjusting LUX trimmer to the left end (⊖), so that SenSwitch only switch on the light at certain darkness.

To set proper darkness for SenSwitch operation, rotate the trimmer clockwise from left end position slowly when the ambient light level is preferred, stop rotating once the light is on.

DETECTION PATTERN

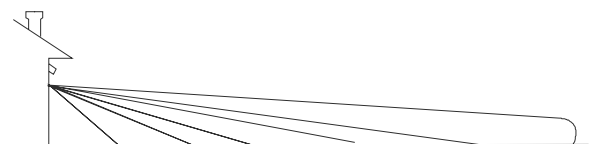
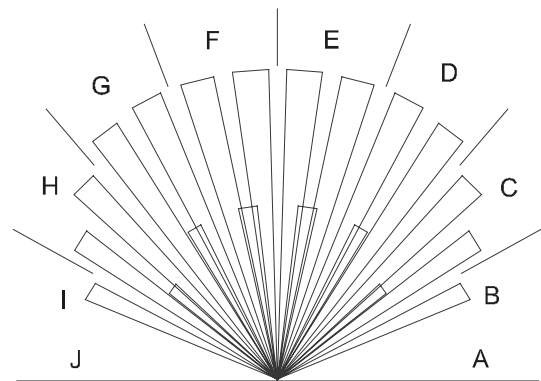
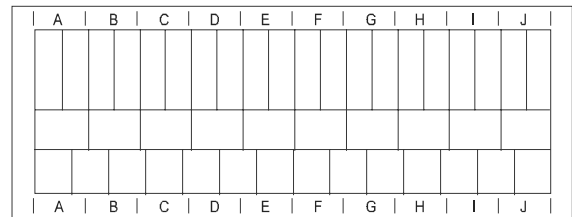

SPECIFICATIONS

- Power supply As unit rated
- Maximum load **LC-780** : 10A resistive
..... **LC-780HD** : 16A resistive
..... **LC-780LV** : 10A resistive
- Detection angle..... 150° wide
- Detection range 18 meter (60 ft) at 25°C
- Detection speed ... 0.15 ~ 3 m/sec.
- Mounting height.... 1.8 ~ 3.0 m
- Delay time..... 8 seconds ~ 8 minutes (approx.)
- Lux range..... 2 ~ 2000 lux (approx.)
- Sensor head tilt..... 80° vertical
- Protection rate IP54
- Op. temperature ... -20°C ~ 50°C (-4°F ~ 122°F)
- Dimensions..... 125 x 105 x 62 mm

Specifications are subject to change without prior notice.